

Site manual

Resin decorative
coverings

- Wallcrete Living
- Wallpaper Living
- Patina Living
- Stripe Living

kerakoll

Contents

Resin decorative coverings

Wallcrete Living	06
Wallpaper Living	18
Patina Living	28
Stripe Living	40



Resin decorative coverings

Wallcrete Living
Wallpaper Living
Patina Living
Stripe Living

Use

Decorative walls of domestic environments (living rooms, bedrooms, hallways and stairs) as well as commercial ones (showrooms, restaurants, shops and offices).

Wallcrete Living

Water-based resin covering with a coloured trowelled texture.

The matt and monochromatic surface of Wallcrete is characterized by irregularities and textured details resulting from an exclusive hand-made processing that enhances the natural vibration of colours.

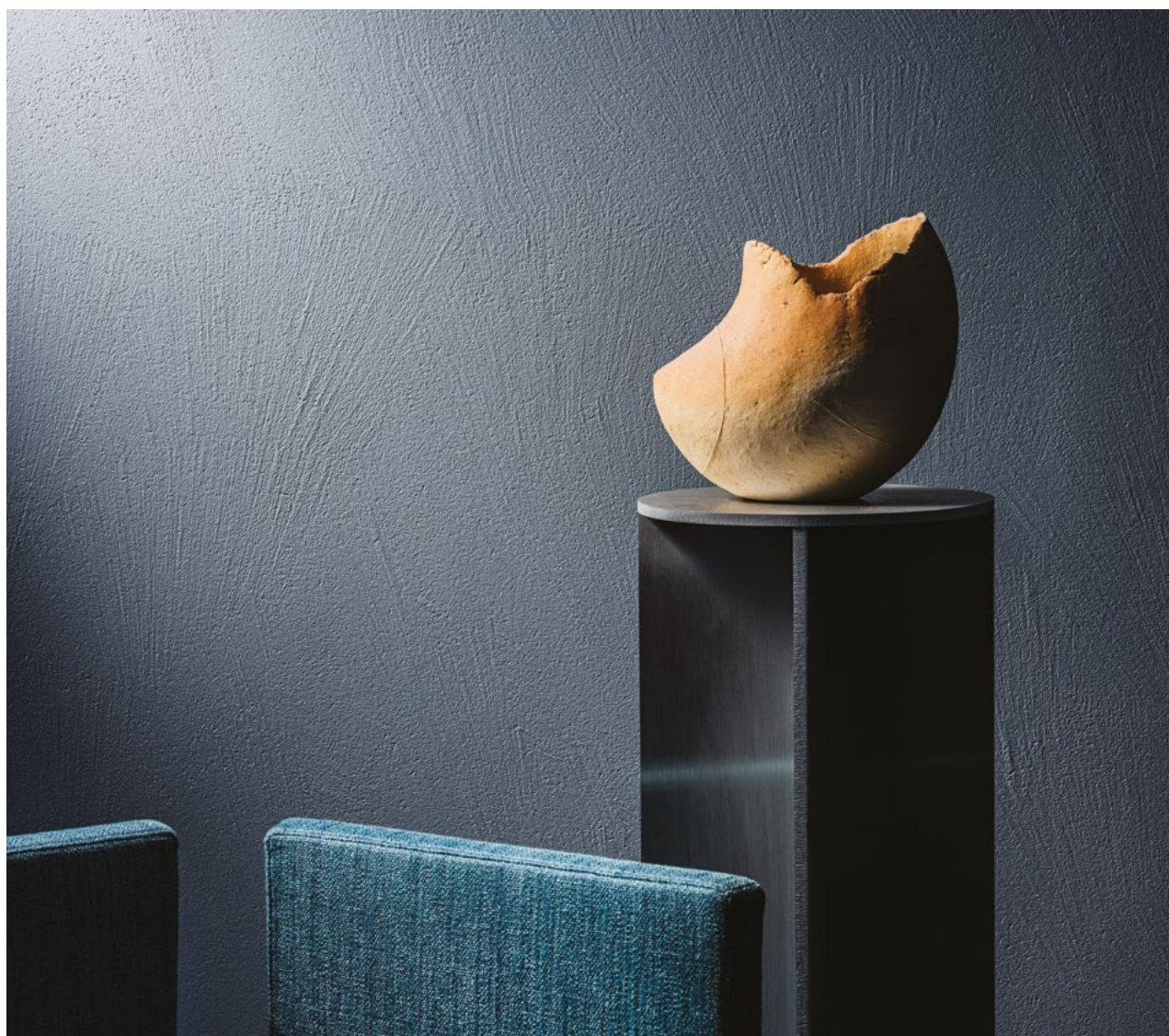

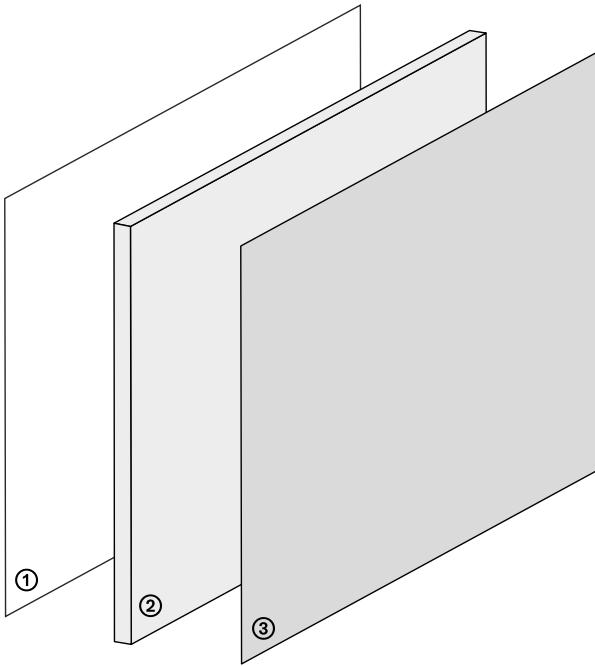

① Layer → Priming

Universal Wall Primer

② Layer → Skimming

Wallcrete

③ Layer → Coloured finish

Decor

① Layer → Priming

Preparation

Warnings about substrates

- The substrates must be permanently dry and free from rising damp.
- Temperature range for application: from +10 °C to +30 °C.
- Relative environmental humidity: ≤ 75%.

Suitable substrates

- Cement based finishing products, lime and gypsum.
- Substrates made with plasterboard and fibre-cement panels.
- Plywood and MDF panels.

Universal Wall Primer

Water based universal primer for walls.



Products

Pack – 1 l - 5 l - 10 l



Coverage

≈ 150 – 200 ml/m²

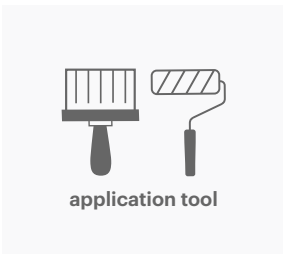

Tools

Brush and roller

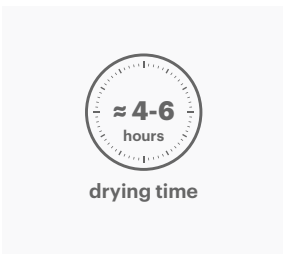

Time

Waiting time for overlaying: ≈ 4 - 6 hours for the subsequent application of **Wallcrete**

② Layer → Skimming

Preparation

Ready-to-use

→ Remix the product inside the container to ensure the mixture is of an even consistency.

Wallcrete

Texturizing base finishing coat for **Wallcrete** Living resin covering.



Products

Pack – 5 kg - 15 kg



Coverage

≈ 1.8 kg/m² for two coats



Tools

Trowel 2 spreader

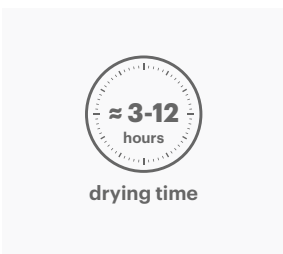

Time

Once the material has hardened: ≈ 3-12 hours

② Layer → Skimming

Wallcrete



→ Apply the 1st coat of **Wallcrete** spreading the product with small and even strokes of the spreader over the entire surface.

Tip: a drop of water may be added in order to make the product more workable.

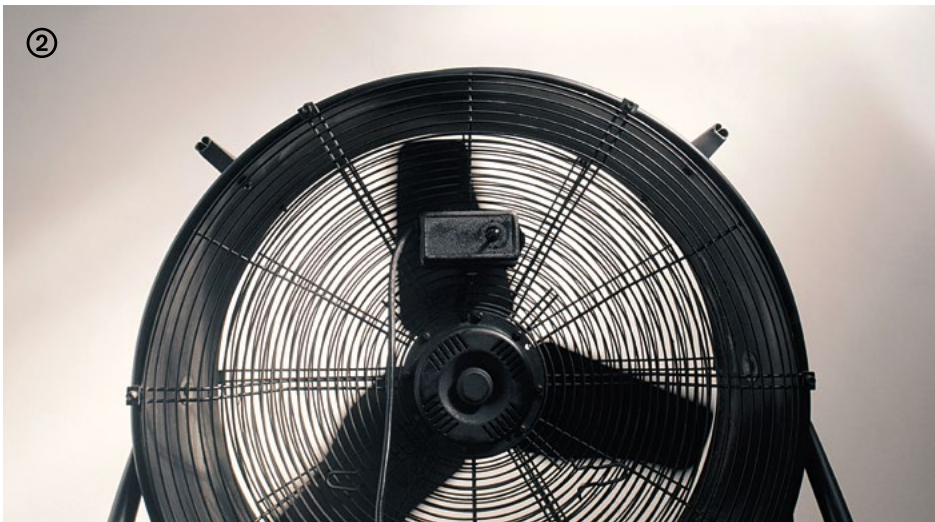

→ To speed up drying times (especially in damp environments and/or with little air circulation), the use of a fan is recommended.



Tip: in order to improve the visibility of the processing, **Wallcrete** in paste form can be coloured by adding a few drops of **Decor** of the same shade as the final colour.



- Apply the 2nd coat once the material has hardened (3-12 hours).
- The 2nd coat has the purpose to define the final texture of the surface; therefore, spread the product smoothing it out completely with small and even strokes of the spreader.

Tip: if crests or flashes are present, sand in order to remove them before applying the 2nd coat.

③ Layer → Coloured finish

Preparation

Ready-to-use

→ Remix the product inside the container to ensure the mixture is of an even consistency.

Decor

Water-based decorative resin-paint with washable and wipeable matt-finish and high chromatic intensity.



Products

Pack – 1.5 l - 4 l - 10 l



Coverage

≈ 200 ml/m² for two coats

Dilution – max 5-10%

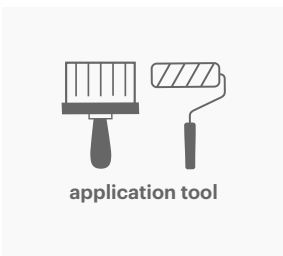

Tools

Brush and roller

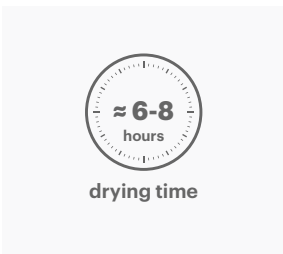

Time

Waiting time between 1st and 2nd coat: ≥ 6 hours

③ Layer → Coloured finish

Decor



- After 4-6 hours from the **Wallcrete** application, sand the surface with 80-120 grain sandpaper in order to remove any small imperfections and to make the surface smooth and pleasing to the touch.
 - **Decor** must be carefully applied with a roller over the whole surface in 2 coats, either pure or diluted to a maximum of 5 - 10%.
- Tip: proceed with shaping by passing over the laid film while it is still wet.

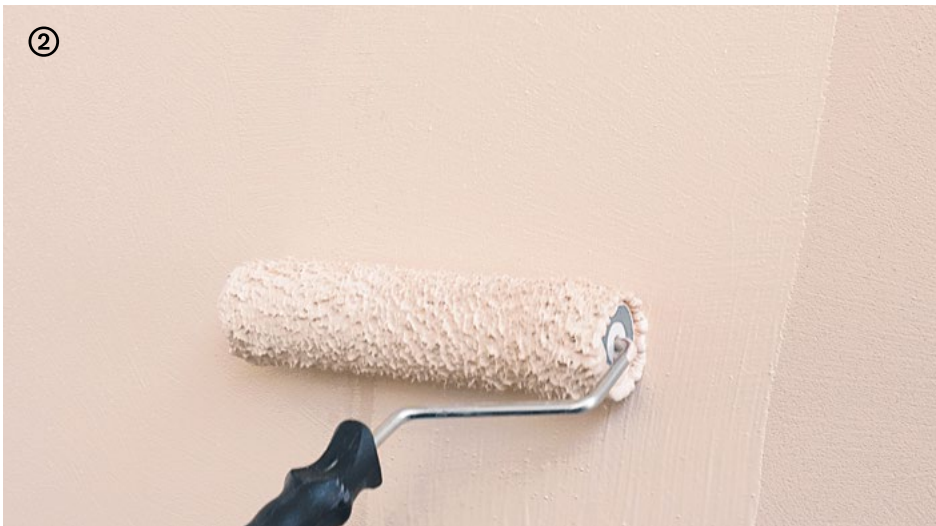

→ **Leave at least 6 hours between the first and second coats.**

Tip: in cases where different batches of coloured product are used, it is advisable to mix the various quantities together so as to avoid slight differences in tone.

WallpaperLiving

Water-based resin covering with a coloured superflat smooth finish.

The matt and monochromatic surface of Wallpaper is ultra-smooth and silky to the touch. Its essential charm creates a minimalist atmosphere of great elegance and formal purity.



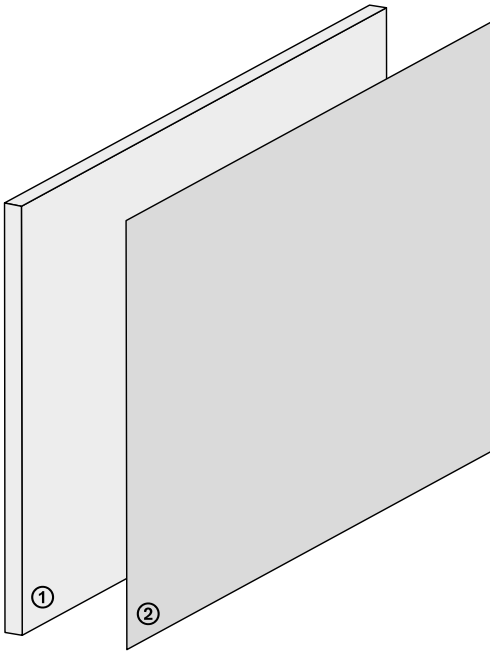

① Layer → Skimming

Wallpaper Living

② Layer → Coloured finish

Decor

① Layer → Skimming

Preparation

Warnings about substrates

- The substrates must be permanently dry and free from rising damp.
- Relative environmental humidity: $\leq 75\%$.

Suitable substrates

- Cement based finishing products, lime and gypsum.
- Substrates made with panels in plasterboard.

WARNING

- Remix before use; the paste must be smooth, consistent and without lumps.

Tip

- Porous substrates with a reduced level of cohesion must always be compact and absorbent; if this is not the case, they must be strengthened with Universal Wall Primer.

Wallpaper Living

Smooth finish plaster for **Wallpaper Living** resin covering.



Products

Pack – 20 kg



Coverage

On plasterboard or finishes with grain size ≤ 0.5 mm $\approx 0.6-0.8$ kg/m²

On finishes with grain size ≥ 0.5 mm $\approx 1.3-1.5$ kg/m²



Tools

Trowel 2 spreader

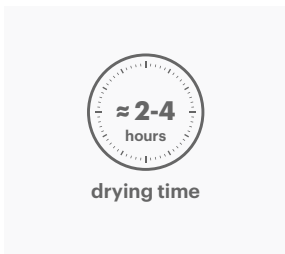

Time

Waiting time between 1st and 2nd coat: $\approx 2 - 4$ hours

Waiting time for **Decor**: $\approx 24-48$ hours

① Layer → Skimming

Wallpaper Living



→ Apply the 1st coat of **Wallpaper Living** smoothing the product on the surface in order to even and level it.

Tip: a drop of water may be added in order to make the product more workable.



→ Apply the product on the previous dry coat, until a perfectly even surface is achieved.

→ Before applying **Decor**, check that the surface is perfectly even; if necessary, apply a further coat.

Tip: for a professional standard finishing coat, we recommend applying at least 3 coats.

If crests or flashes are present, sand in order to remove them before applying a further coat and before applying **Decor** coloured finish.

② Layer → Coloured finish

Preparation

Ready-to-use

→ Remix the product inside the container to ensure the mixture is of an even consistency.

Decor

Water-based decorative resin-paint with washable and wipeable matt-finish and high chromatic intensity.

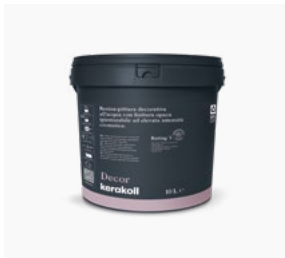

Products

Pack – 1.5 l - 4 l - 10 l



Coverage

≈ 200 ml/m² for two coats

Dilution – max 5-10%

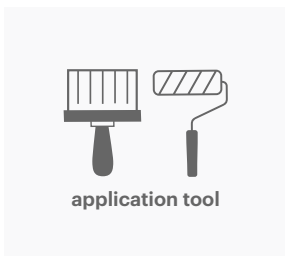

Tools

Brush and roller

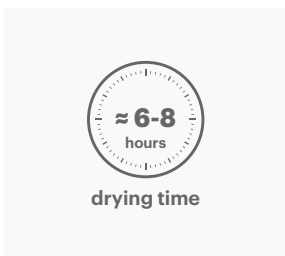

Time

Waiting time between 1st and 2nd coat: ≥ 6 hours

② Layer → Coloured finish

Decor



→ Before applying **Decor**, sand the surface with 80-220-grain sandpaper in order to make the surface perfectly smooth and pleasing to the touch.



→ **Decor** must be carefully applied with a roller over the whole surface in 2 coats, either pure or diluted to a maximum of 5 - 10%.

Tip: proceed with shaping by passing over the laid film while it is still wet.



- Help yourself with a spotlight to create a grazing light flush with the wall, and be able to check the perfect evenness of the surface.
- If there are small imperfections, grout promptly with Wallpaper before proceeding with the subsequent coats.



- Leave at least 6 hours between the 1st and 2nd coats.
- Tip: in cases where different batches of coloured product are used, it is advisable to mix the various quantities together so as to avoid slight differences in tone.

PatinaLiving

Water-based resin covering with a delabr  plaster texture and natural shaded finish.

The surface of Patina is velvety to the touch and characterized by ripples and material vibrations resulting from the imperfections of hand-made processing.

The uneven colour and the unique effects in light reflection create a sophisticated sense of imperfection.



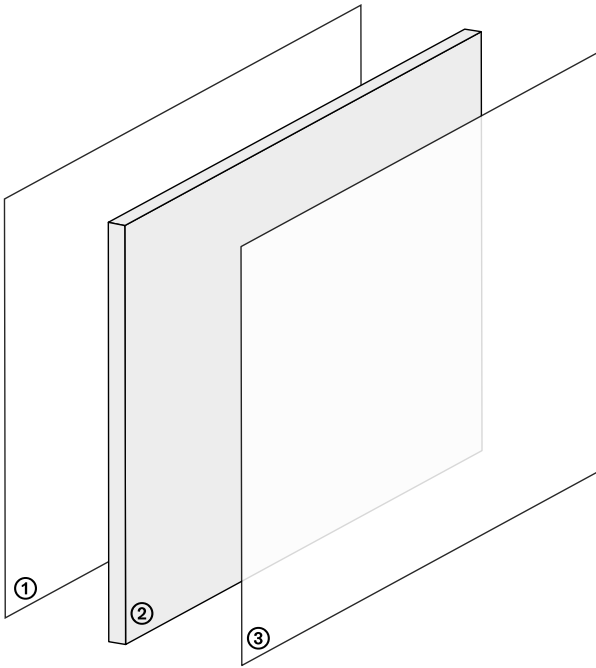

① Layer → Priming

Universal Wall Primer

② Layer → Skimming

Patina

③ Layer → Impregnating protective product

Finish

① Layer → Priming

Preparation

Warnings about substrates

- The substrates must be permanently dry and free from rising damp.
- Temperature range for application: from +10 °C to +30 °C.
- Relative environmental humidity: ≤ 75%.

Suitable substrates

- Cement based finishing products, lime and gypsum.
- Substrates made with plasterboard and fibre-cement panels.
- Plywood and MDF panels.

Universal Wall Primer

Water based universal primer for walls.



Products

Pack – 1 l - 5 l - 10 l



Coverage

≈ 150 – 200 ml/m²

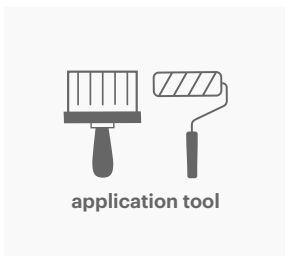

Tools

Brush and roller

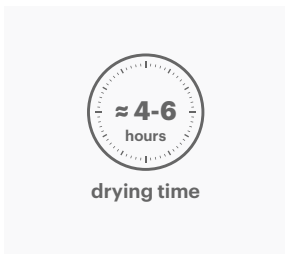

Time

Waiting time for overlaying: ≈ 4 - 6 hours for the subsequent application of Patina

② Layer → Skimming

Preparation

Ready-to-use

→ Remix the product inside the container to ensure the mixture is of an even consistency.

Patina

Coloured texturizing finishing coat for Patina Living resin covering.



Products

Pack – 15 kg



Coverage

≈ 1.8 kg/m² for two coats



Tools

Trowel

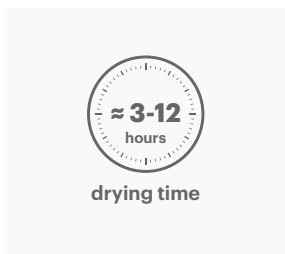

Time

Once the material has hardened: ≈ 3-12 hours

② Layer → Skimming

Patina



→ Apply the 1st coat of **Patina** spreading the product with small and even strokes of the spreader over the entire surface.

Tip: when applying, keep the spreader flat so as not to leave raised crests or notches.



→ To speed up drying times (especially in damp environments and/or with little air circulation), the use of a fan is recommended.



→ **Apply the 2nd coat once the material has hardened (3-12 hours).**
Tip: if crests or flashes are present, sand in order to remove them before applying the 2nd coat. A drop of water may be added in order to make the product more workable.

③ Layer → Impregnating protective product

Preparation

Ready-to-use

→ Remix the product inside the container to ensure the mixture is of an even consistency.

Finish

Protective water based impregnating product for Patina Living resin covering.



Products

Pack – 1.5 l



Coverage

≈ 150 ml/m² for two coats

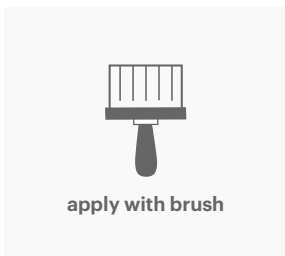

Tools

Brush

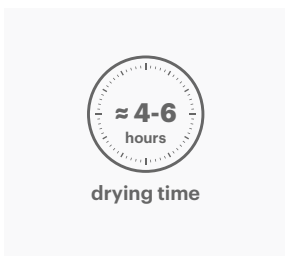

Time

Waiting time between 1st and 2nd coat: ≈ 4 - 6 hours

③ Layer → Impregnating protective product

Finish



→ Once the coloured texturizing finishing coat **Patina** has completely dried, apply the 1st coat of **Finish** by brush without sanding.

Tip: proceed with crossed strokes from the top downwards.



→ After 4-6 hours, sand the surface with 80-120-grain sandpaper in order to remove any small imperfections and to make the surface smooth and pleasing to the touch.



→ Remove any dust with a dry flat brush or a cotton cloth and then apply the 2nd coat of Finish.

Stripe Living

Water-based resin covering with coloured trowelled material texture.
The surface of Stripe Living is modelled by the expert hand of the craftsman, for a refined decorative effect, almost like a wallpaper with a precious textured aspect.



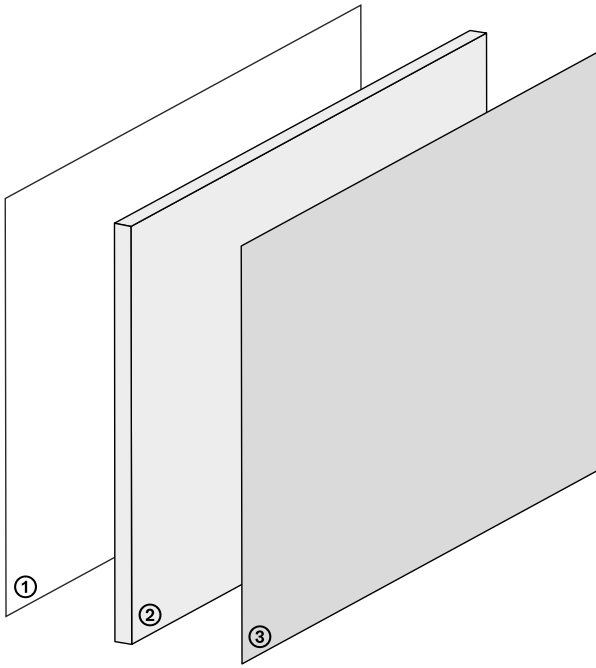

① Layer → Priming

Universal Wall Primer

② Layer → Texture

Stripe

③ Layer → Coloured finish

Decor

① Layer → Priming

Preparation

Warnings about substrates

- The substrates must be permanently dry and free from rising damp.
- Temperature range for application: from +10 °C to +30 °C.
- Relative environmental humidity: ≤ 75%.

Suitable substrates

- Cement based finishing products, lime and gypsum.
- Substrates made with plasterboard and fibre-cement panels.
- Plywood and MDF panels.

Preparation of substrates

- In order to obtain the standardized effect, it is necessary to apply Stripe on a smooth and even surface.
- If necessary, smooth the substrates with Wallpaper or Wallpaper Living.

Universal Wall Primer

Water based universal primer for walls.



Products

Pack – 1 l - 5 l - 10 l



Coverage

≈ 150 – 200 ml/m²

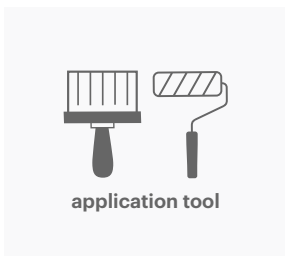

Tools

Brush and roller

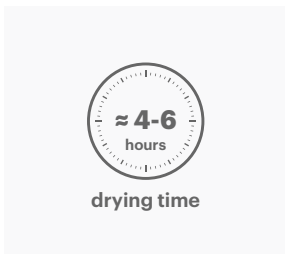

Time

Waiting time for overlaying: ≈ 4 - 6 hours for the subsequent application of Stripe

② Layer → Texture

Preparation

Ready-to-use

→ Always remix Stripe before applying.

Tip

→ Apply the product pure, not diluted.

Stripe

Coloured base texturizing agent for Stripe Living resin covering.



Products

Pack – 4 l - 10 l



Coverage

≈ 700 ml/m² for two coats

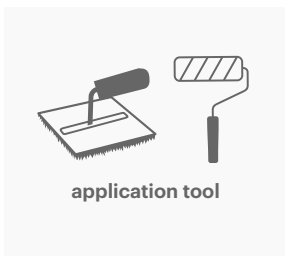

Tools

Roller and stripe tool

The stripe tool mat can be easily removed for cleaning and to make it suitable for application in corners, niches, grooves, etc.

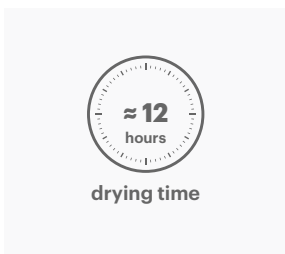

Time

Waiting time between 1st and 2nd coat: ≥ 12 hours

Waiting time for overlayering: ≈ 12 hours

② Layer → Texture

Stripe_ Application with Ultrafine Lined and Textile effect

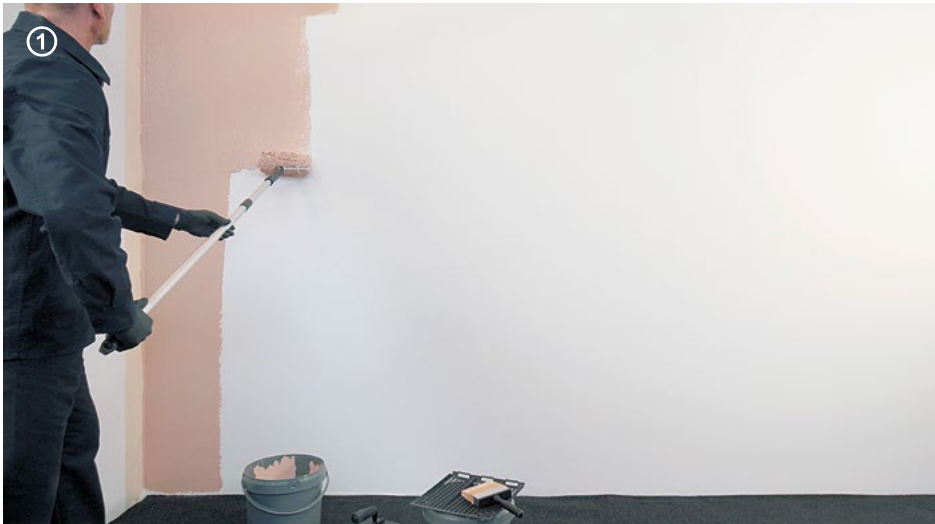

- Apply the 1st coat of the product pure (not diluted).
- Use a long-bristle roller, laying on the surface an abundant quantity of the product, approximately 400 ml/m² with a thickness of approximately 2 mm.
- Apply vertical strips (1-1.5 m wide) of Stripe, using the wet-on-wet method.



→ Pass over the wet strip with the **Stripe** tool while the product is still fresh, creating horizontal lines, making sure to keep the geometry parallel with the plane.



Tip: the use of a laser leveller pointed at the wall might be useful in order to keep the lines perfectly horizontal.

② Layer → Texture

Stripe



Application with Ultrafine Lined effect

- Apply the 2nd coat of the product pure (not diluted), following the same procedure used for the application of the 1st coat.
- Pass over the wet strip with the Stripe tool, creating horizontal lines, making sure to keep the geometry parallel with the plane.



Application with Textile effect

→ Apply the 2nd coat of the product pure (not diluted), following the same procedure used for the application of the 1st coat.

→ Pass over the wet stripe with the Stripe tool, creating vertical lines.

Tip: in case of areas presenting slightly accentuated lines, a subsequent coat of Stripe may be applied, even locally, blending the patch layer with the Stripe tool.

③ Layer → Coloured finish

Preparation

Ready-to-use

→ Remix the product inside the container to ensure the mixture is of an even consistency.

Decor

Water-based decorative resin-paint with washable and wipeable matt-finish and high chromatic intensity.

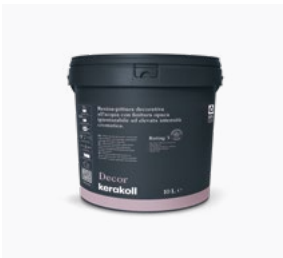

Products

Pack – 1.5 l - 4 l - 10 l



Coverage

≈ 200 ml/m² for two coats

Dilution – max 5-10%

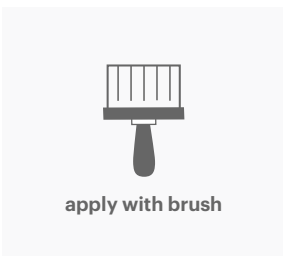

Tools

Brush

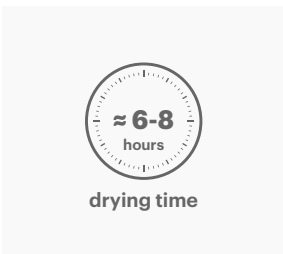

Time

Waiting time between 1st and 2nd coat: ≥ 6 hours

③ Layer → Coloured finish

Decor

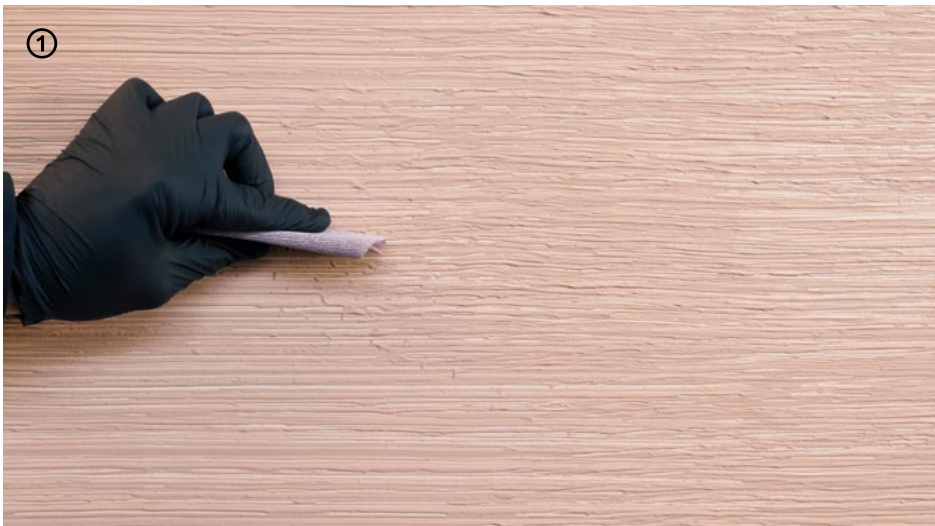

→ Lightly sand by hand in order to remove any small flaws or lumps before applying **Decor**.



→ **Decor** must be applied over the whole surface, by brush, in one or two coats, either pure or diluted to a maximum of 5 - 10%, following the direction of the horizontal lines.

Surfaces and Uses

Surfaces

paints

Absolute
Decor

Resin-based Coating materials

Decorative coverings
Wallcrete Living
Wallpaper Living
Patina Living
Stripe Living

Technical coverings*

Wallcrete
Wallpaper
Patina

Microresina

Microresina
Microresina Floor
Microresina Parquet

Cementoresina

Cementoresina
Cementoresina Wall

Legno+Color

Legno+Color S, M, L

Finishes for external application

Outdoor Paint
Outdoor Plaster

Skirting board

Invisibile

Use

Walls and ceilings

Absolute
Decor

Decorative walls

Wallcrete Living
Wallpaper Living
Patina Living
Stripe Living

Technical walls*

Wallcrete
Wallpaper
Patina
Cementoresina Wall

Floors

Cementoresina
Legno+Color S, M, L
Microresina Floor
Microresina Parquet

Re-color**

Microresina

External facades

Outdoor Paint
Outdoor Plaster

* Walls of bathrooms and kitchens.

** Doors, internal and external fixtures, joinery and ceramic coverings.

Kerakoll Spa
via dell'Artigianato 9
41049 Sassuolo (MO) Italy
T +39 0536 816 511
info@kerakoll.com

Kerakoll Brera Studio
via Solferino 16
20121 Milano (MI) Italy
T +39 02 620 867 81

N.B.

This Site manual has been drafted on the basis of the best technical and practical knowledge of Kerakoll S.p.A.

It is, however, a set of guides and information of a general nature that do not consider the real situations of individual structures; therefore, the coverage information is to be considered merely indicative.

Kerakoll does not intervene directly in the building site conditions, the specific design of the project, and the execution of the work; the information and guidelines mentioned here do not commit Kerakoll in any way.

The designer in charge is responsible for the entire structural design in accordance with Italian Ministerial Decree 17/01/2018 and its amendments or additions.

All rights reserved. © Kerakoll. All rights to the content of this publication are reserved in accordance with applicable law.

The duplication, publication, and distribution, in full or in part, of all material contained herein, are expressly forbidden without written authorization. Additions and/or amendments to this information may be made over time by KERAKOLL Spa; for the latest version, see www.kerakoll.com.

KERAKOLL Spa shall therefore be liable for the validity, accuracy and updating of information provided only when taken directly from its institutional website. For information on the product safety data, refer to the corresponding sheets provided in accordance with the law along with the health labelling on the packaging. Finally, it is advisable to perform a preliminary test of each product to verify its suitability for your purposes.

kerakoll



kerakoll.com